



BRANDON[®]

I N D U S T R I E S

1601 Wilmeth Road
McKinney, Texas 75069
Phone: 972.542.3000
Toll Free: 800.247.1274
brandonindustries.com

CLEARPATH™ Pet Station

made from the following parts:

POLE:

PART# CP3X8
3" x 8' FLUTED CHANNEL POLE
WALL THICKNESS .125"

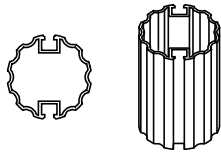

FINIAL:

PART# FIN-A3
ACORN FINIAL
HEIGHT: 6.7"
WIDTH: 4.2"



FINIAL:

PART# FIN-B3
BALL FINIAL
HEIGHT: 6.5"
WIDTH: 4.8"

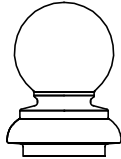

FINIAL:

PART# FIN-CS3
CIRCLE STAR FINIAL
HEIGHT: 7.3"
WIDTH: 5.6"



DISPENSER:

PART# CP-D01
HEIGHT: 14"
WIDTH: 6.75"

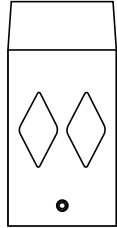

FINIAL:

PART# DB-30
BALL FINIAL
HEIGHT: 1.7"
WIDTH: 3.9"

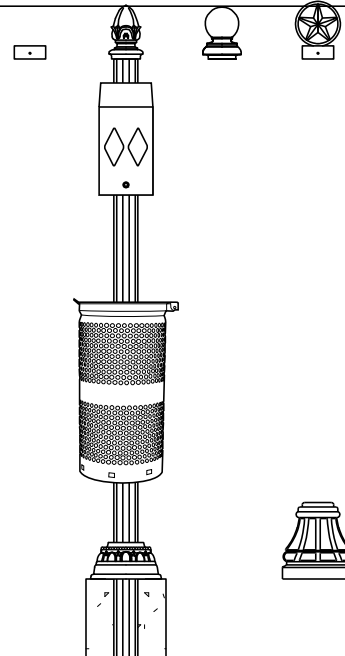
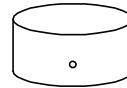

TRASH CAN:

PART# CP-T01
HEIGHT: 23"
WIDTH: 12"

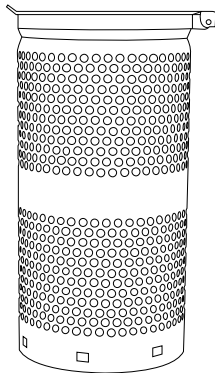

BASE:

PART# 2PCD
TWO PIECE BASE
HEIGHT: 10"
WIDTH: 9"

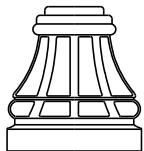

BASE:

PART# SB-23
SLIP OVER BASE
HEIGHT: 4.5"
WIDTH: 7"

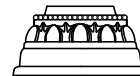

NOTES:
COMPLETE UNIT SHOWN WITH 2' BELOW GRADE BURIAL. FOUNDATION SHOULD BE DESIGNED TO MEET LOCAL CODES AND THE REQUIREMENTS OF SOIL CONDITIONS. DRAWING FOR INFORMATION ONLY, NOT INTENDED FOR CONSTRUCTION PURPOSES.