



# BRANDON<sup>®</sup>

I N D U S T R I E S

1601 Wilmeth Road  
McKinney, Texas 75069  
Phone: 972.542.3000  
Toll Free: 800.247.1274  
brandonindustries.com

## CLEARPATH™ Pet Station

made from the following parts:

### POLE:

PART# SPS3X7  
3" x 7" SMOOTH POLE  
WALL THICKNESS .125"

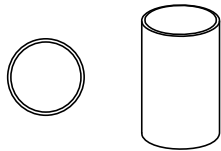

### FINIAL:

PART# FIN-A3  
ACORN FINIAL  
HEIGHT: 6.7"  
WIDTH: 4.2"



### FINIAL:

PART# FIN-B3  
BALL FINIAL  
HEIGHT: 6.5"  
WIDTH: 4.8"

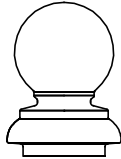

### FINIAL:

PART# FIN-CS3  
CIRCLE STAR FINIAL  
HEIGHT: 7.3"  
WIDTH: 5.6"



### DISPENSER:

PART# CP-D01  
HEIGHT: 14"  
WIDTH: 6.75"

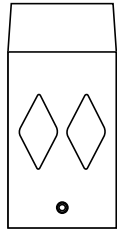

### FINIAL:

PART# DB-30  
BALL FINIAL  
HEIGHT: 1.7"  
WIDTH: 3.9"

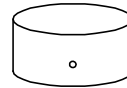

### TRASH CAN:

PART# CP-T01  
HEIGHT: 23"  
WIDTH: 12"

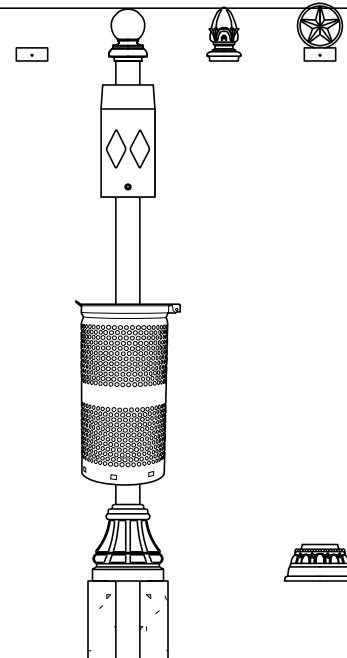
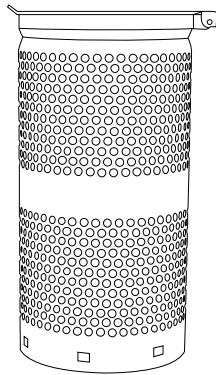

### BASE:

PART# 2PCD  
TWO PIECE BASE  
HEIGHT: 10"  
WIDTH: 9"

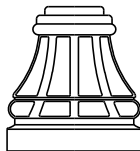

### BASE:

PART# SB-23  
SLIP OVER BASE  
HEIGHT: 4.5"  
WIDTH: 7"

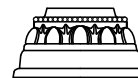

NOTES:  
COMPLETE UNIT SHOWN WITH 2' BELOW GRADE BURIAL. FOUNDATION SHOULD BE DESIGNED TO MEET LOCAL CODES AND THE REQUIREMENTS OF SOIL CONDITIONS. DRAWING FOR INFORMATION ONLY, NOT INTENDED FOR CONSTRUCTION PURPOSES.